



**Balaji
MicroTechnologies**

Tri-Linear Series: BMT-2098C-CL User Manual

Digital Line Scan Cameralink Camera

Balaji MicroTechnologies Pvt. Ltd.
(A Unit of B.B. Group of Companies)

Corporate Headquarter: New Delhi, India

Sales/business Operation: D-2/20, Sector-10 | DLF Faridabad-121006 |
Haryana, **INDIA**

Tel # +91-129-4006203 | +91-129-6561300

Email (For Overseas Sales): sales.overseas@balaji-microtechnologies.com

Email (For India Sales): sales.india@balaji-microtechnologies.com

Website: <http://www.balaji-microtechnologies.com/>

Table of Contents

1. INTRODUCTION	5
1.1 TYPICAL SPECIFICATION	5
1.2 PRODUCT KEY FEATURES	5
1.3 CAMERA CONFIGURABLE FUNCTIONS	6
1.4 SAFETY MEASURE	6
1.4.1 <i>Supply voltage Limitation</i>	6
1.4.2 <i>Power Supply of camera</i>	6
1.4.3 <i>Warranty</i>	7
2. ELECTRICAL & INTERFACE	8
2.1 CONNECTORS	8
2.2 POWER SUPPLY CONNECTOR	8
2.3 CAMERA LINK CONNECTOR	9
3. CAMERA FUNCTIONS AND CONTROL	11
3.1 CAMERA COMMAND & CONTROL	11
3.2 CAMERA LINK TIMING AND SYNC MODES	13
3.2.1 <i>Cameralink Timing</i>	13
3.2.2 <i>Free-run mode without Shutter</i>	13
3.2.3 <i>Free-run mode with shutter</i>	14
3.2.4 <i>External Sync modes</i>	15
3.3 INTEGRATION TIME & LINE RATE	15
3.4 ELECTRIC SHUTTER	16
3.5 AREA OF INTEREST (AOI) FUNCTION	16
3.6 CAMERA RESET FUNCTION	16
3.7 GAIN & OFFSET SETTING FUNCTION	17
3.7.1 <i>Offset & Gain Setting (recommended)</i>	18
3.8 TYPES OF TEST IMAGES	18
3.8.1 <i>Mode-01 test image</i>	18
3.8.2 <i>Mode-02 Test Image</i>	19
4. SERIAL CAMERA CONFIGURATION	19
4.1 CAMERA COMMAND DETAILS	19
4.2 CAMERA RETURN STRINGS	20
4.3 SPECIAL COMMAND	20
5. MECHANICAL DRAWINGS:	20
6. ORDERING CODE	21

List of Tables

TABLE 1 : CAMERA SPECIFICATION	5
TABLE 2-LIMITS FOR SUPPLY VOLTAGE.....	6
TABLE 3 CONNECTOR INFORMATION.....	8
TABLE 4 POWER CONNECTOR	8
TABLE 5 CAMERALINK CONNECTOR PINS DETAILS	9
TABLE 6 CAMERA COMMAND LIST	12
TABLE 7 CAMERA TIMING SPECIFICATION DETAILS	13

List of Figures

FIGURE 1 CONNECTORS OF THE CAMERA	8
FIGURE 2 POWER SUPPLY CONNECTOR	8
FIGURE 3 CAMERALINK CONNECTOR PINS	9
FIGURE 4 CAMERA TIMING	13
FIGURE 5 FREE RUN MODE WITHOUT SHUTTER	14
FIGURE 6 FREE RUN MODE WITH SHUTTER	14
FIGURE 7 EXTERNAL SYNC MODE TIMING	15
FIGURE 8 AREA OF INTEREST (AOI) FUNCTION	16
FIGURE 9 CC2 RESET TIMING	17
FIGURE 10 OFFSET & GAIN SETTING OF THE CAMERA	17
FIGURE 11 MODE-01 TEST IMAGE	18
FIGURE 12 MODE-02 TEST IMAGE	19
FIGURE 13 CAMERALINK CAMERA MECHANICAL DRAWING	20

1. Introduction

1.1 Typical Specification

Name	Specification
Resolution	2098 Tri-Linear CCD (KLI-2113)
Pixel size	14×14 (μm×μm) (8 lines spacing)
MAX. date rate	20 MHz×3
MAX. line rate	≈9.2 KHz
Lens mount	Nikon F-Mount
Spectral response	400nm ~ 700nm Typical
Data Format	8 bit x 3
Sensor Dynamic Range	76 db
Output Format	Cameralink base (1T24)
Sync/Trigger Input	CC1
Sync modes	Free-run / External Sync
Integration time	16 bit through Cameralink Serial Port
Electronic Shutter	10μs MIN. 16bit Setting via Camera Link Serial
Gain & Offset	Programmable through Cameralink Serial Port
Offset Range	1 LSB to 510 LSB, 8 bit Resolution (for 12bit output data format with 2LSB step)
Gain Range	0 V/V to 16 V/V (MAX. 24dB), 10 bit Resolution
Power supply	Single 12 V (DC), 5%
Power dissipation	< 4W
Working temp.	-10°C to 50°C / 20% to 80%
Storage temp.	-40°C to 75°C / 10% to 90%
Dimensions	TBD
Weight	< 500 GM

Table 1 : Camera Specification



BMT-2098C-CL
BalaJi MicroTechnologies

1.2 Product Key Features

- ✚ The camera is equipped with On Semiconductor, USA Line scan CCD KLI-2113 which is Tri-linear color CCD sensors.
- ✚ Area of interest functions (AOI)
- ✚ Two test image mode which makes more fault finding efficiency in the field.
- ✚ Our camera design is compatible with several framegrabbers in available in the global market as it offers very easy serial communication & camera configuration.
- ✚ The CC1 control line is used by the camera as external sync inputs, CC2 line is optional line which may use for camera reset (driver part). For external sync mode settings, The camera integration is synchronized with external sync line.

1.3 Camera configurable functions

- ✚ AOI function
- ✚ Camera reset via CC2 line with changeable polar setting
- ✚ Camera Link DVAL, FVAL, LVAL output format
- ✚ 16bit Integration time setting
- ✚ Gain & Offset Control
- ✚ 16bit Electric Shutter Control
- ✚ Sync Modes
- ✚ 16bit Integration time setting

1.4 Safety Measure

1.4.1 Supply voltage Limitation

MIN.	TYP.	MAX.
9 V DC	12V DC	17 V DC

Table 2-Limits for Supply Voltage

1.4.2 Power Supply of camera

	<p style="text-align: center;">Warning!</p> <ul style="list-style-type: none"> Check camera supply voltage before using the camera. Cut-off camera's power supply before plug or un-plug and connectors. Do not reverse the polarity of the input power! Reversing the polarity of the input power can severely damage the camera and leave it non-operational.
--	---

	<p style="text-align: center;">Information!</p> <p>Without sufficient cooling, the camera can get hot enough during operation. Allow sufficient air circulation around the camera to prevent internal heat build-up in your system and to keep the camera housing temperature during operation below 50°C. Provide additional cooling such as fans or heat sinks if necessary.</p>
---	---

1.4.3 Warranty

- ✓ Camera comes with 12 months warranty from the date of Invoice subject to following below terms.
- ✓ Do not remove any of the camera's labels. If labels are removed, user accepts that the warranty of the camera is void.
- ✓ Read this Manual first before using the camera
- ✓ Keep foreign matter outside of the camera
- ✓ Do not open the housing. Touching internal components may damage them. Be careful not to allow liquids, flammable, or metallic material inside the camera housing. If operated with any foreign matter inside, the camera may fail or cause a fire.
- ✓ **Electromagnetic fields:** Do not operate the camera in the vicinity of strong electromagnetic fields. Avoid electrostatic charging.
- ✓ **Transporting:** Only transport the camera in its original packaging. Do not discard the packaging.
- ✓ **Cleaning:** Avoid cleaning the surface of the CCD sensor if possible. If you must clean it, use a soft, lint free cloth dampened with a small quantity of high quality window cleaner. Do not use ethylated alcohol. Because electrostatic discharge can damage the CCD sensor, you must use a cloth that will not generate electrostatic charge during cleaning (cotton is a good choice).
- ✓ To clean the surface of the camera housing, use a soft, dry cloth. To remove severe stains, use a soft cloth dampened with a small quantity of neutral detergent, then wipe dry. Do not use volatile solvents such as benzene and thinners; they can damage the surface finish of the camera.

2. Electrical & Interface

2.1 Connectors

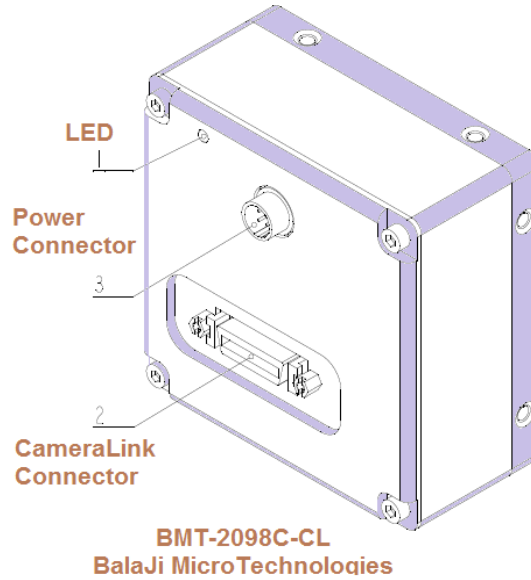

Figure 1 Connectors of the camera

Notes	
1	LED Status
2	CameraLink Connector
3	Power Connector

Table 3 connector information

2.2 Power Supply Connector





Figure 2 Power supply connector

Male Connector (YC8-4T) (HR10A Compatible)		
No.	Signal	Function
1,2	VDD	9V—15V DC
3,4	GND	GND

Table 4 Power Connector

	Information!
GNDs are connected together inside to the Ground of the camera.	

	<p>Information!</p> <p>VDDs are connected together inside the camera.</p>
---	--

	<p>Warning!</p> <ul style="list-style-type: none"> Do not reverse the polarity of the input power to the camera. Reversing the polarity of the input power can damage the camera and leave it non-operational
---	---

2.3 Camera Link Connector

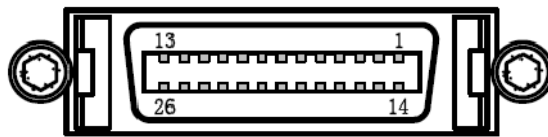



Figure 3 Cameralink Connector Pins

Type: Ribbon Female Connector (3M MDR26 Mini D)						
No.	Signal	No.	Signal	Name	Direction	Function
1	SHIELD	14	SHIELD	-----	-----	
2	X0-	15	X0+	X0	OUT	Cameralink Data 0
3	X1-	16	X1+	X1	OUT	Cameralink Data 1
4	X2-	17	X2+	X2	OUT	Cameralink Data 2
5	XCLIK-	18	XCLIK+	XCLIK	OUT	Cameralink Clock
6	X3-	19	X3+	X3	OUT	Cameralink Data 3
7	SerTC+	20	SerTC-	SerTC	IN	Serial To Camera
8	SerTFG-	21	SerTFG+	SerTFG	OUT	Serial to Framegrabber
9	CC1-	22	CC1+	CC1	IN	Camera Control 1
10	CC2+	23	CC2-	CC2	IN	Camera Control 2
11	CC3-	24	CC3+	CC3	IN	Camera Control 3
12	CC4+	25	CC4-	CC4	IN	Camera Control 4
13	SHIELD	26	SHIELD	-----	-----	

Table 5 CameraLink Connector Pins details

2.3.1

	<p>Information!</p> <p>Pins (1, 13, 14, 26)</p> <p>The camera mechanical housing is connected with the outer shield of the cable and is then electrically isolated from the PCB's inside the camera. The inner shield of the camera link connector is connected with the digital ground of camera circuit.</p>
---	---



Warning!

- **User must use high quality CameraLink Cables to ensure good signal integrity & quality for high speed data transfer.**

3. Camera functions and control

3.1 Camera Command & Control

Please refer to **Section-4 under Serial Camera Configuration** for the detailed protocol of the camera communication. The camera's configuration is set through the serial interface which meets the camera link standard.

Setting	Command	Parameter	Description
Global Gain	G=	0~1023	Gain Setting for all Channels fomr 0 V/V to 16 V/V The Default value is 64 (0 db)
Red Gain	GR=	0~1023	Red Channel Gain Setting
Green Gain	GG=	0~1023	Green Channel Gain Setting
Blue Gain	O=	0~255	O = 80 (160LSB) Offset Setting for all channels from 0 LSB to 510 LSB (2 LSB step), The default value is 80 (160 LSB).
Global Offset	OR=	0~255	Red Channel Offset
Odd Offset	OG=	0~255	Green Channel Offset

Setting	Command	Parameter	Description
Blue Offset	OB=	0~255	Blue Channel Offset
Sync Modes	M=	0	Free Run Mode, Default camera integration time setting
		1	Invalid Setting
		2	Sync Modes (External signal Integration time Setting)
Data Source	S=	0	Default CCD Video Data
		1	Test Image 01
		2	Test Image 02
Shutter Value	U=	0~65535	Default Value is 122, Shutter Value for R,G,B Channels
	UR=	0~65535	Red Channel Shutter Value
	UG=0	0~65535	Green Channel Shutter Value
	UB=0	0~65535	Blue Channel Shutter Value
Integration Time	I=	0~65535	Default Value is 0, Valif for Free Run Modes & Trig Modes, Integration time setting
LVAL OUTPUT	L=	0	LVAL output as line Valid
		1	Sample, L=0
		2	LVAL Output low
		3	LVAL Output High
FVAL OUTPUT	F=	0	FVAL output low (Default Value)
		1	FVAL Output High
		2	FVAL Output as line Valid
		3	FVAL Output as line Valid
DVAL OUTPUT	D=	0	DVAL output High (Default Value)

Setting	Command	Parameter	Description
		1	DVAL Output low
		2	DVAL Output as line Valid
		3	DVAL Output as line Valid
CC2 RESET	2E=	0	CC2 Camera Reset Disabled (Default)
		1	CC2 Camera Reset Enable
CC2 POLAR	2P=	0	CC2 Camera Reset Pulse positive (Default)
		1	CC2 Camera Reset Pulse Negative
AOI FUNCTION	A=	0	AOI Function disabled (Default)
		1	Enable AOI Function
AOI START Position	B=	0~(n-1)	Default Value is 0, Start Position of AOI Window
AOI END Position	C=	1~n	End position of AOI window, the value must larger than AOI start value.
Save Configuration	W=	1	Save current configuration to default working set.
Camera RESET	R=	1	Reset the camera, only core logic of of the camera is reset by this command.
Save User Set	X=	1~3	Save current configuration to user set 1, 2 or 3.
Restore Configuration	Z=	0~3	Restore user configuration set, Z=0 will restore Factory configuration set.
Special Command	!=	0	Display Camera Information
		1	Display camera function set
		3	Display camera setting range & other information
		4	Display current camera setting lists.

Table 6 Camera Command List

Important:

1. Valid Pixels of the camera (Single Line) = n
2. Electric shutter value setting range is obtained by integration setting value, see instructions below

3.2 Camera Link Timing and Sync Modes

3.2.1 Cameralink Timing

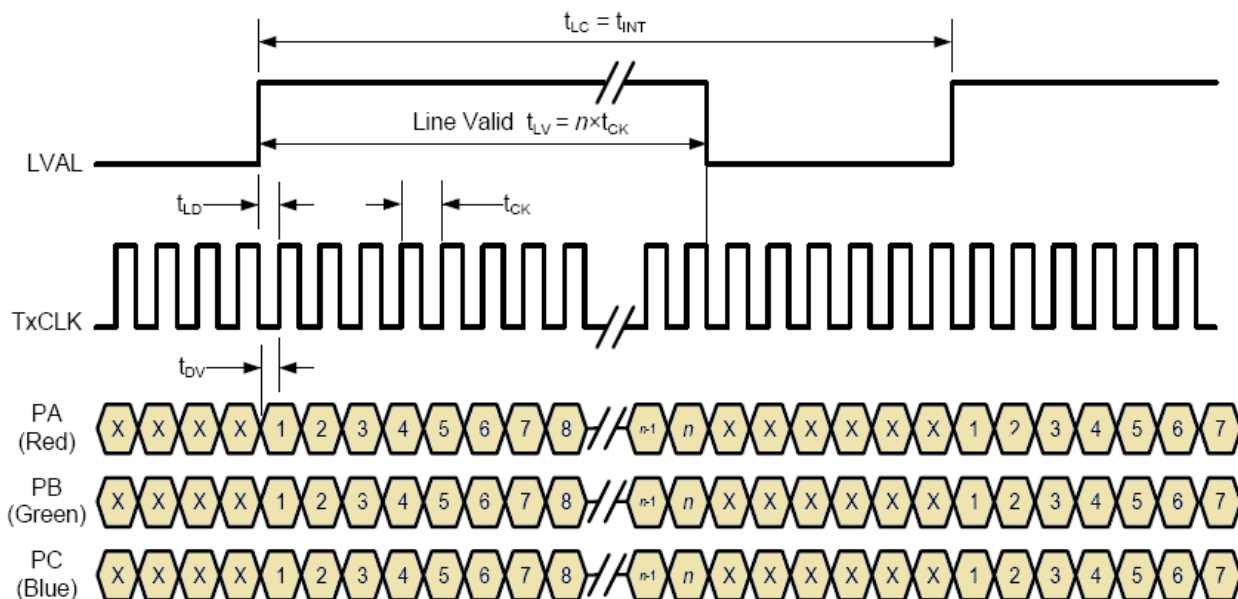

Figure 4 Camera Timing

FVAL is not use for the camera and shall be configure as the frame grabber required, The camera use TxCLK as the data clock output, LVAL default is the line valid output. This camera doesn't have electric shutter function; the LVAL period is equal to integration time while electric shutter function is disabled.

Symbols	Description	Minimum	Typical Value	Maximum
tCK	Pixel Clock duration	---	---	---
tLD	Timing of LVAL to first Data Valid Rising-Edge	5 ns	1/2 tCK	3/4 tCK
tDV	Timing of Data Valid to Clock Rising-Edge	---	1/2 tCK	---
tTRIG	CC1 pulse width for Trig Mode	300 ns	---	---
tSYNC	CC1 pulse width for Sync Mode	300 ns	---	---
tIDLY	Timing of CC1 Rising-Edge to Integration Start	---	1.6 μ s	---
t2W	CC2 Reset Pulse Width	25 ns	---	---
t2DLY	Timing of Deactivating CC2 to Integration Start	---	1.3 μ s	---

Table 7 Camera Timing Specification Details

3.2.2 Free-run mode without Shutter

The integration & read out are control by the camera & start automatically & immediately after previous period. Integration time is set by serial command from 0 to 65535 (16bit). The maximum line rate shall be set by "l=0" command.

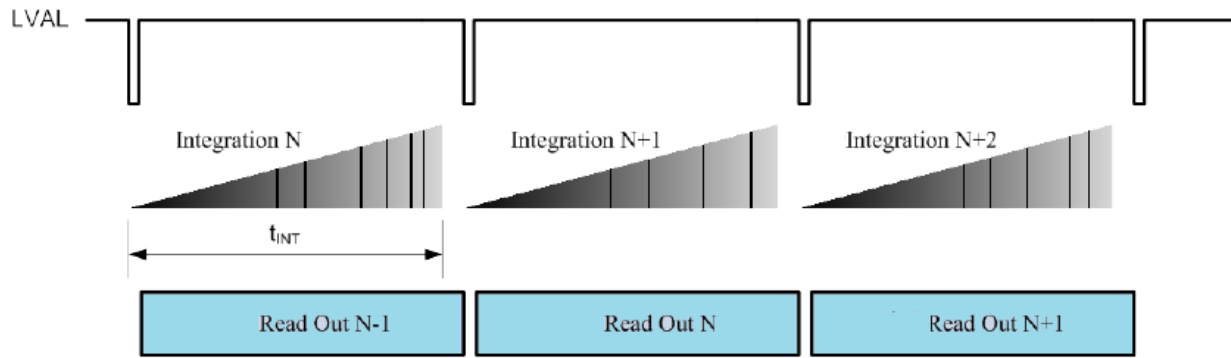

Figure 5 Free run mode without shutter

3.2.3 Free-run mode with shutter

The integration & read out are control by the camera & start automatically & immediately after previous period. Exposure time is set by the electric shutter (“U=XXXXX” command). The maximum shutter time is limited by current integration time setting.

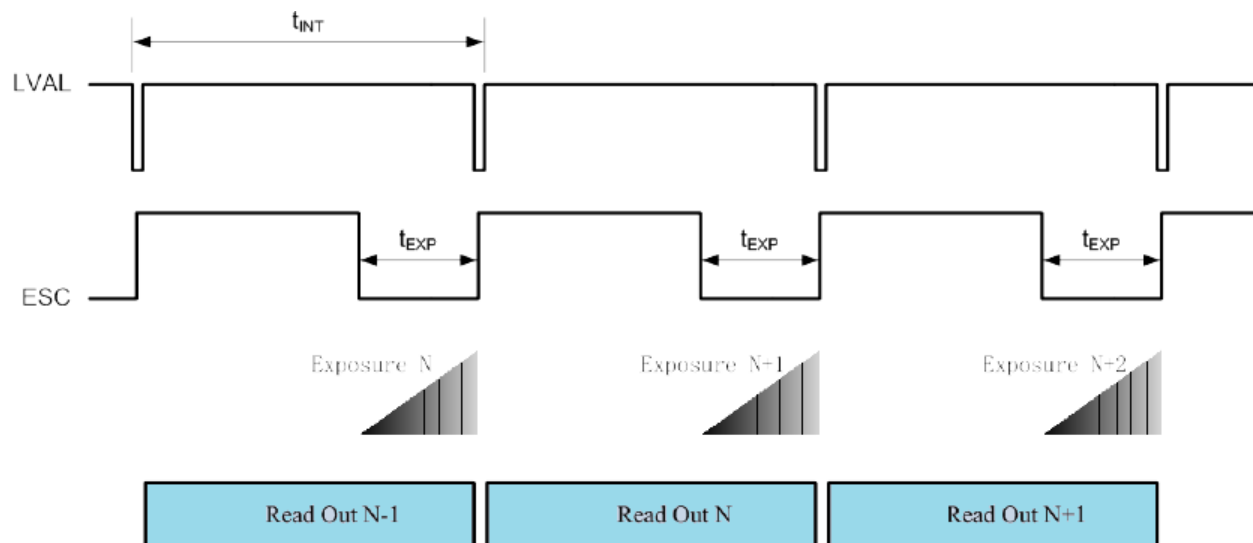



Figure 6 Free run mode with shutter

	<p>Information!</p> <p>Increasing integration time will lower the line rate of the camera. operator can use “!=2” special command to obtain integration step, current integration time and current line rate.</p>
---	--

	<p>Information!</p> <p>The line rate will not be changed with change in electric shutter value. The electric shutter value or exposure time of the camera will not be changed with change in integration time</p>
---	--

3.2.4 External Sync modes

Electric shutter will be automatically disabled by the camera when setting to external sync mode. Integration time is controlled by external sync pulse period from CC1 input.

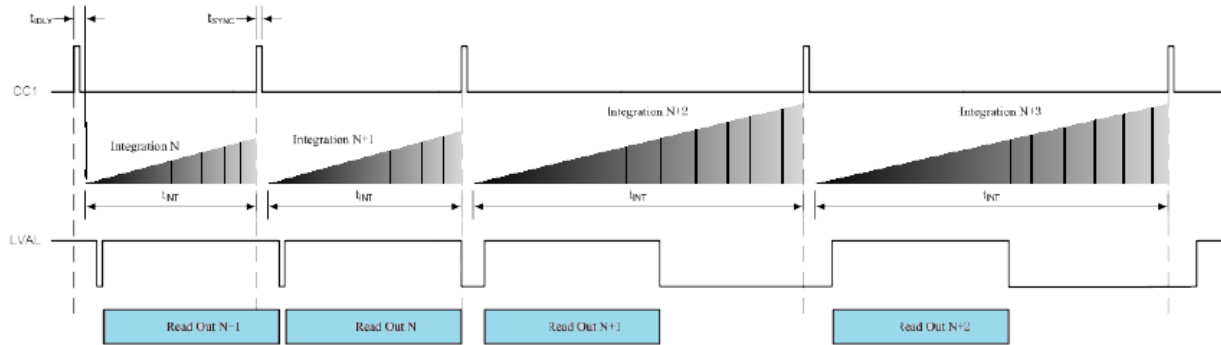

Figure 7 External sync mode timing

3.3 Integration time & line rate

Calculation for integration time is: $t_{INT} = t_{MININT} + (I \times t_{STEP})$

t_{MININT} = (minimum integration time)

t_{STEP} = (step value for integration setting)

I = "I=XXXXX" (current integration setting value with "I=XXXXX" command)

Calculation for line rate is: $LR_{MAX} = \frac{1}{t_{MININT}}$ (Hz)

Camera default integration setting value is 0,

3.4 Electric Shutter

Calculation for shutter value when shutter function enabled is:

$$t_{EXP} = t_{MINEXP} + (U \times t_{STEP})$$

T_{MINEXP} = (minimum exposure time)

t_{STEP} = (step value for shutter setting)

U = “ $U=XXXXX$ ” current shutter setting value with “ $U=XXXXX$ ” command

Electric shutter value should meet below requirement

$$t_{EXP} < t_{INT} - 10.0 (\mu s)$$

For KLI-2113 CCD based RGB cameras with electric shutter function support, using “UR=XXXXX”, “UG=XXXXX” and “UB=XXXXX” commands to setting each color channel’s shutter values. Default setting for each channel is 122.

3.5 Area of Interest (AOI) function

The LVAL signal will change according to AOI setting, when camera’s AOI function is enabled.

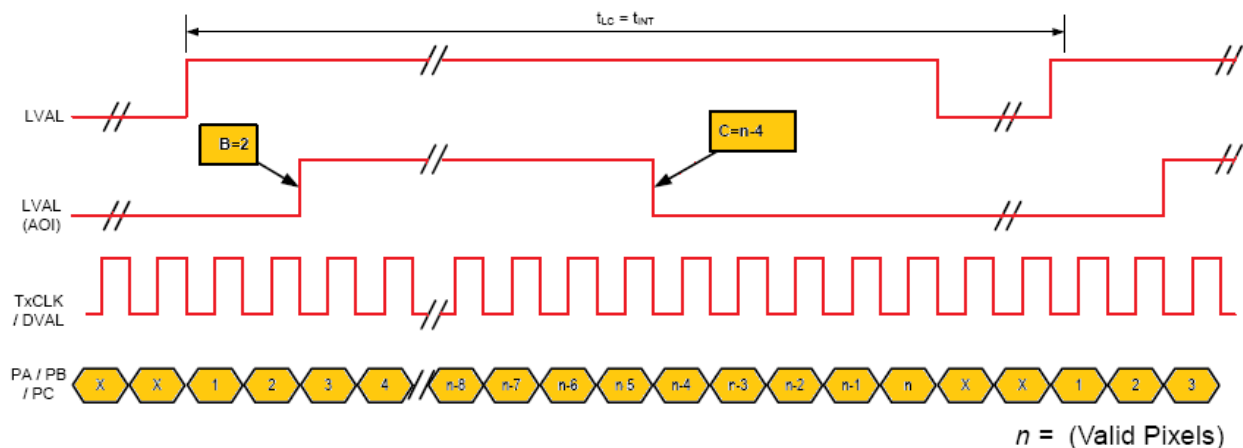



Figure 8 Area of Interest (AOI) function

when Area of Interest (AOI) function is disabled, the LVAL output will cover all 2098 pixels output, when Area of Interest (AOI) is enabled and start point set to “ $B=2$ ” and end point set to “ $C=2094$ ”, the LVAL output will be changed to cover from pixel 3 to pixel 2094 (2092 output data).

	<p>Information!</p> <p>There are few frame grabbers which need to change settings when Area of Interest (AOI) is enabled. Area of Interest (AOI) setting can't increase line rate of the camera.</p>
---	---

3.6 Camera reset function

There are two types of camera reset shall be performed

1. one is the software reset ("R=1" command),
2. the other is the optional CC2 pulse reset.

NOTE: CC2 reset function must be enabled before using it. CC2 reset function can only reset the core logic of the camera while the software reset will reset the whole system.

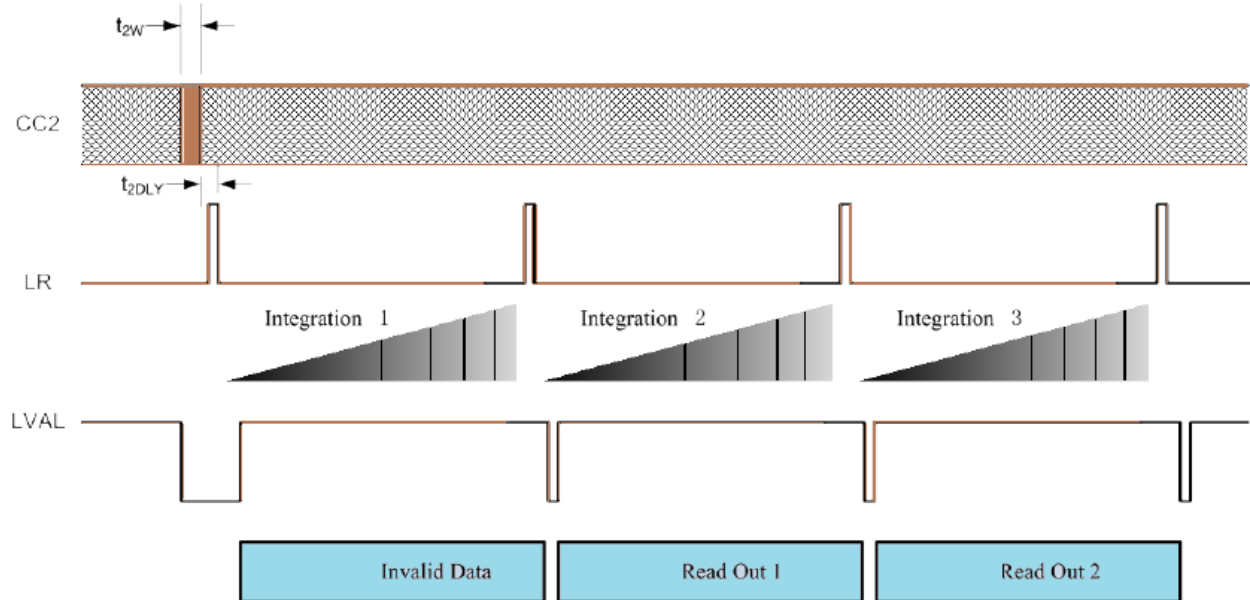

Figure 9 CC2 reset timing

NOTE: Default camera configuration for CC2 reset is disabled.

3.7 Gain & Offset Setting Function

Our Tri-linear Series KLI-2113 CCD sensor based RGB cameras offers a digital 10 bit gain and 8 bit offset setting via serial line. Maximum gain setting value is up to 16V/V (24dB) with 0.015dB steps, default value $G=64$ (1V/V or 0dB); offset step is 2LSB in 12bit output format.

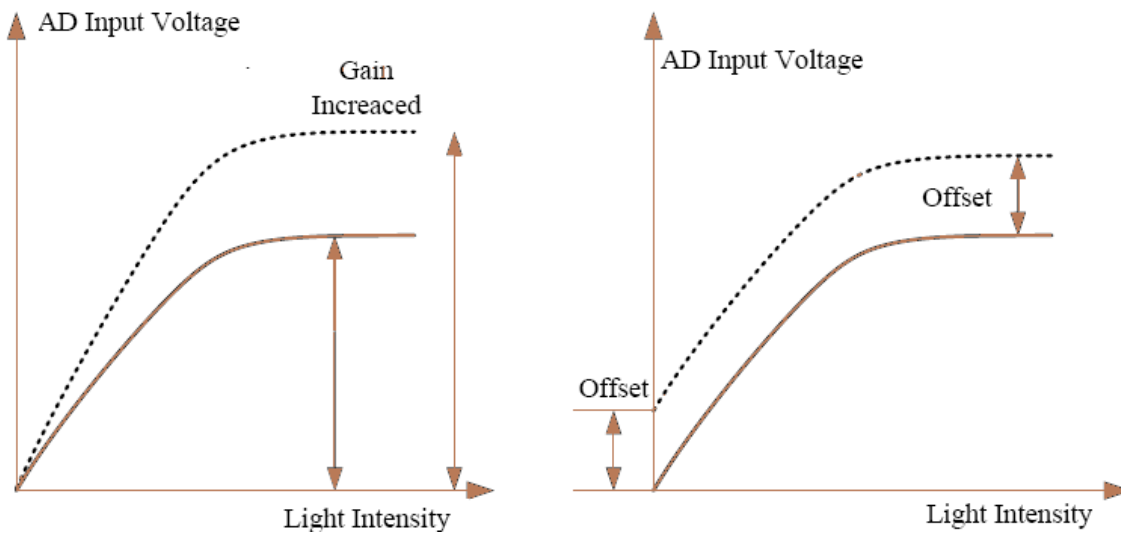



Figure 10 Offset & Gain Setting of the Camera

	<p>Information!</p> <p>Increase the gain will also increase the noise of the camera output, but the total noise to signal (dB) ratio will not change apparently.</p>
---	---

	<p>Information!</p> <p>For Tri-linear KLI-2113 CCD sensor based cameras, the gain and offset of each channel (R, G, B) need to be fine adjusted in field application to obtain ideal white balance and black balance..</p>
---	---

3.7.1 Offset & Gain Setting (recommended)

Offset & Gain Setting (Recommendation)

1. Set all channel to 1X (0dB) gain and maximum offset, serial command “G=64” and “O=255”.
2. Put the camera into total dark environments (for example: mount the lens cap is OK), set each channel's offset value to let the output video data just arrived to zero.
3. Put the camera to acquire a total white object images, set each channel's gain value, make the video output arrived to maximum (255 if output format is 8 bit, 4095 if 12bit).
4. Repeat steps 3), 4).
5. Save settings (“W=1” or “X=n” command).

IMPORTANT INSTRUCTIONS

1. Any time, user can use “Z=0” command to restore factory settings.
2. Avoid too much incident light to the CCD sensor while adjusting due to the limited anti-blooming feature of the CCD sensor.
3. Too much incident light to the CCD sensor will saturate the dark reference of the sensor and make video data drop to nearly zero.

3.8 Types of test images

There are two types of test image is available for testing purpose. The test image is generated inside the FPGA and jump over the AD conversion.

3.8.1 Mode-01 test image

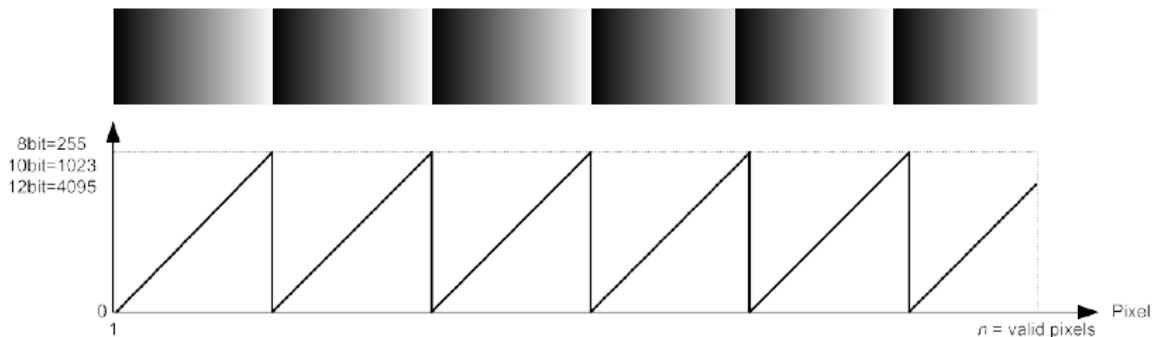

Figure 11 Mode-01 test image

The above test image is a repeated gray scale gradients cycle every 256 pixels.

3.8.2 Mode-02 Test Image

It's is divided into two parts: first half valid pixels image is same as mode 1 of the test image; second half valid pixels is vertical repeated gradients cycle every 256 lines. Please see below:

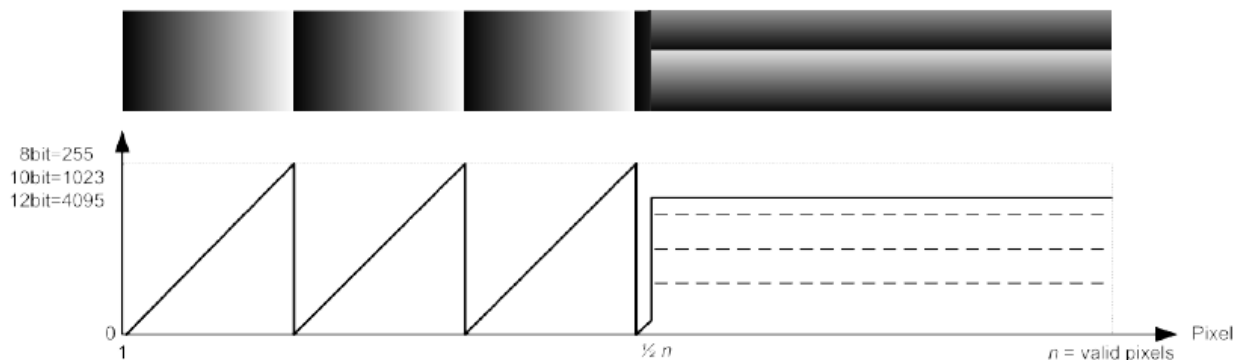

Figure 12 Mode-02 Test Image

IMPORTANT: Test image are based on total valid pixels of the camera. The Area of Interest (AOI) function will not change the test image values.

4. Serial Camera Configuration

The camera link interface provides two LVDS signal pairs to communication between the camera and the frame grabber, it's an asynchronous serial communication base on RS-232 protocol. The serial line's configuration is:

1. Duplex without handshaking
2. 9600 bps, 8 bit, 1 bit (9600 bauds, 8bit data, no parity bit, 1 stop bit)

Signal	Direction	Format	Description
SerTFG	OUT	RS644	Serial to Framegrabber
SerTC	IN	RS644	Serial to Camerr

4.1 Camera command details

Our Tri-linear Series KLI-2113 CCD sensor based RGB cameras are based on ASCII protocol of the serial communication, the command syntax is illustrated as follows:

Command=Parameter

1. Command: one or more characters continued with a "=" character, see section 3.1
2. Parameter: must be one or more characters within "0" to "9".
3. (CR) : Represent the "Enter" character (Hex value is 0x0D), same for below.
4. "Blanc (or SPACE)" character are not allowed in the command syntax.

4.2 Camera return strings

<This Section to be added shortly>

4.3 Special Command

<This Section to be added shortly>

5. Mechanical drawings:

UNIT = MM

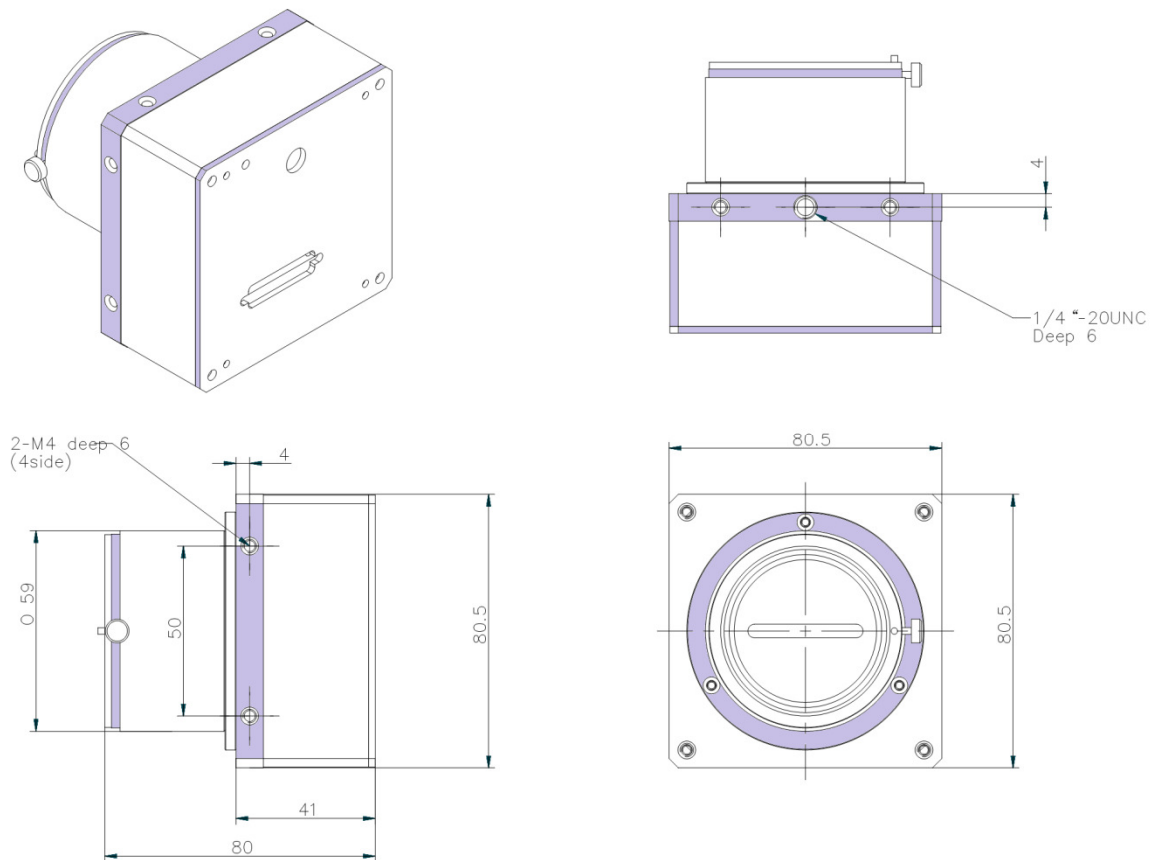

Figure 13 CameraLink Camera mechanical drawing

IMPORTANT:

1. Mount the lens after removing the protection caps of the camera to avoid dust gathering on CCD's optic window.
2. The camera's typical weight (without lens adapter and lens) is <450 gm.

6. Ordering code

Model Number	Description
BMT-2098C-CL	2098 Pixel CCD Cameralink Colour Line Scan Camera
BMT-2098M-CL	2098 Pixel CCD Monochrome Cameralink Line Scan Camera

For more product information or inquiry, please contact

Balaji MicroTechnologies Pvt. Ltd.
(A Unit of B.B. Group of Companies)

Corporate Headquarter: New Delhi, India

Sales/business Operation: D-2/20, Sector-10 | DLF Faridabad-121006 |
Haryana, **INDIA**

Tel # +91-129-4006203 | +91-129-6561300

Email (For Overseas Sales): sales.overseas@balaji-microtechnologies.com

Email(For India Sales): sales.india@balaji-microtechnologies.com

Website: <http://www.balaji-microtechnologies.com/>